

Study of cooperative adaptive cruise control system spacing policy

Ma Jun^{1,a}, Gong Zaiyan^{2,b}, Zhang Qianwen^{1,c}

¹College of Design and Innovation, Tongji University, Shanghai 201804, China

²School of Automotive Studies, Tongji University, Shanghai 201804, China

^amajun.tongji@foxmail.com, ^bgongzaiyan@foxmail.com, ^czhangqianwen@tongji.edu.cn

Keywords: Cooperative adaptive cruise control (CACC) system, spacing policy, traffic scenario simulation

Abstract: This paper improves the spacing policy of cooperative adaptive cruise control system. Improved policy can predict the velocity variation trend of former vehicle by considering the former vehicle' acceleration via vehicle-to-vehicle wireless communication. As a result, it improves the perspectiveness and anti-interference performance of distance control. In order to verify whether the improved policy is more effective, adaptable and safe, this paper uses MATLAB/Simulink to do the computer simulation under four common traffic scenarios. Simulation compares three different spacing distances' desirable distance, actual distance, velocity and acceleration. It turns out that distance control has better adaptability and dynamic performance by using improved spacing policy. Under steady following and approaching scenario, improved spacing policy effectively improves the ride comfort. On the other hand, it better driving safety under cut in and hard brake scenario.

1. Introduction

Cooperative adaptive cruise control (CACC) system is an extension of the adaptive cruise control (ACC) functionality. CACC system can acquire the more information through wireless communication, such as signal light, traffic signs, and velocity and acceleration of the vehicle in front^[1]. It utilizes a multi-train coordinated control method to achieve cooperative platooning control.

Compared to ACC system, consumers can have more intelligent, comfort and secure driving experience by using CACC system. In terms of performance, it can shorten car-following distance and reduce velocity fluctuation in a vehicle queue^[3]. When driving on a traffic-free road, using CACC can help reducing emission. When a traffic accidents occurred, it can get the traffic moving again more quickly. From the point of obtaining information, ACC uses radar and CACC uses wireless communication. The accuracy and reliability of wireless communication is better than radar. In the meantime, wireless communication devices operate regardless of the weather, while radar does. Therefore, more and more research scholars and government institutes participated in the study of CACC system and have made significant progress.

CACC system is mainly composed by control system, sensing system and devices of communications access for land mobiles^[2]. Sensing system collect surrounding information and transfer data to control system. Control system is the critical design of CACC system. It output throttle percentage and brake pressure according to the data from sensing system. Hardware part is its body, and spacing policy and control policy are the brain. The spacing policy transforms the data from sensing system into desirable distance and pass it to control policy. Then control policy output throttle percentage and brake pressure in order to control driving state. At present, most researchers studied on control policy and used existing ACC system's spacing policy. But the spacing policy have effects on car-following performance, security, comfort and traffic capacity. Hence, spacing policy design can't be ignored.

Spacing policy can be classified into two kinds: constant spacing policy and variable. Darbha and other researchers verified that constant spacing policy would result in instability platoon, because of considering control factors too little. As a result, constant spacing policy has now been

weeded out.

Spacing policy based on time headway which is belonged to variable spacing policy is widely used today. The time headway is the time takes when two continuous vehicles' headstocks pass one site on a straight road. Now time headway policy contains two kinds: constant (CTH) and variable time headway (VTH) policy. CTH policy is came up by Loannou^[6] at the earliest, and is used widely in mass-produced ACC system. In recent years continued in-depth study of CTH policy, Chiang and Juang indicated it makes car-following distance too large so that road usage and access rates are seriously affected. This is because CTH policy leaves the speed of vehicle in front out of consideration^[7]. Lin studied the effects of traffic flow when chose different time headways. He reach the conclusion that different traffic scenarios need to set diverse time headways^[8]. What's more, more and more research scholars verified that the performance of using CTH policy in complex traffic circumstance was not good enough^[9, 11]. According to CTH policy's shortcomings, Borqua, Yanakiev and other research fellows put forward VTH policy^[12, 13]. Borqua believed that time headway was proportional to self-vehicle's velocity. While Yanakiev agreed that time headway was concerned with both two vehicles' velocity. And now Yanakiev's VTH policy is used by more researchers.

As we all know, CACC system can obtain many data through wireless communication. So if spacing policy concerns about more circumstance information, the adaptability to complex traffic scenario is better. Therefore this paper improves VTH policy based on Yanakiev's and conducts simulations in order to verify whether the improved policy is suitable.

2. Study on spacing policy

The VTH policy of Yanakiev is

$$t_h = t_0 - k_a v_r \quad (1)$$

Where t_h is time headway, t_0 and k_a are constants greater than zero, v_r is relative speed between two vehicles.

Analysis of formula (1), it's easy to get that when the v_r is constant, no matter the vehicle in front is accelerating or decelerating, the following distance will not be change. Butwhen the vehicle in front is decelerating, distance should be lager to avoid rear-end collisions.

As to CACC system can acquire the velocity and acceleration of vehicle in front directly, adding these information in spacing policy will enhance policy's perspectiveness. As a result, when the vehicle in front is accelerating, the following distance will be smaller to avoid other vehicles cutting in. When decelerating, distance will be larger to keep safe.

Improvement of Yanakiev's VTH policy shows below

$$t_s = \text{sat}(t_0 - k_a v_r - k_b a_f) \quad (2)$$

Where t_0 , k_a , k_b are constants greater than zero. In particular, calculation ignores signal delay.

Because the time headway can't be negative or too big, so it's necessary to use saturation function to keep time headway in reasonable value range.

$$t_s = \text{sat}(t_0 - k_a v_r - k_b a_f)$$

$$= \begin{cases} t_{s_max} & \text{if } t_0 - k_a v_r - k_b a_f > t_{s_max} \\ t_0 - k_a v_r - k_b a_f & \text{if } t_{s_min} < t_0 - k_a v_r - k_b a_f < t_{s_max} \\ t_{s_min} & \text{otherwise} \end{cases} \quad (3)$$

Define $\text{sat}(\cdot)$ as saturation function, t_{s_max} as upper limit of time headway, t_{s_min} as lower limit of time headway.

Then, the formula of desirable distance is

$$\Delta x_e = t_s v + \Delta x_0 \quad (4)$$

Define Δx_e as the desirable distance, Δx_0 as minimal safe distance between two vehicles.

Formula (3) and (4) are the improved spacing policy based on VTH. This policy improves the perspectiveness and anti-interference performance of distance control by predict velocity disturbance of the vehicle in front.

When vehicle in front equipped with CACC keeps an even speed, the spacing error must be convergent. Spacing error means difference between desirable distance and actual distance. In other words, when acceleration of the vehicle in front approaches zero, the spacing error should also be close to zero. Otherwise, this spacing policy is unstable. Below is theoretical evidence of improved spacing policy.

Due to

$$\delta = \Delta x - \Delta x_e$$

Bring formula (4) into the above formula can get calculation formula of spacing error.

$$\delta = \Delta x - \Delta x_0 - t_s v$$

Differentiating both sides of the above formula so that

$$\dot{\delta} = v_e - t_s \dot{v} - t_s \dot{v} \quad (5)$$

Differentiating both sides of formula (3) so that

$$\dot{t}_s = \begin{cases} -k_a \dot{v}_r - k_b \dot{a}_f & \text{if } 0 < t_0 - k_a v_r - k_b a_f < t_{s_max} \\ 0 & \text{otherwise} \end{cases} \quad (6)$$

Constructing the following formula according to formula (6) so that

$$\theta_t(t_s) = \begin{cases} 1 & 0 < t_0 - k_a v_r - k_b a_f < t_{s_max} \\ 0 & \text{otherwise} \end{cases}$$

Thus formula (6) can be rewritten as

$$\dot{t}_s = \theta_t(t_s)(-k_a \dot{v}_r - k_b \dot{a}_f) \quad (7)$$

No matter what kind of CACC system control policy is, its control purpose is ensuring desirable distance is in accord with actual distance. When actual distance is greater than desirable distance between two continuous vehicles, CACC system should increase velocity of the behind vehicle to reduce car-following distance, and vice versa.

Description above can be formulated as follows:

$$v_r = h\delta \quad (8)$$

Where, h is a constant less than zero, δ is the spacing error.

Differentiating both sides of formula (8) so tha

$$\dot{v}_r = h\dot{\delta} \quad (9)$$

Bring formula (7) and (9) into (5), so that

$$\dot{\delta} = h\delta - t_s \dot{v} - \theta_t(t_s)(-k_a \dot{v}_r - k_b \dot{a}_f)v$$

Because this theoretical evidence is about when the front vehicle's acceleration approaches zero, whether the spacing error is also close to zero. Thus the above formula can be rewritten into

$$\dot{\delta} = h\delta - t_s \dot{v} + \theta_t(t_s)k_a \dot{v}_r v \quad (10)$$

When the front vehicle's acceleration approaches zero, it means that the front vehicle is running at a steady speed. Therefore, $\dot{v}_f = 0$, so that

$$\dot{v}_r = -\dot{v} \quad (11)$$

Bring formula (9) and (11) into (10), so that

$$\dot{\delta} = h\delta + t_s h\dot{\delta} + \theta_t(t_s)k_a h\dot{\delta}v$$

Simplify above formula can be

$$\dot{\delta} = \frac{h}{1 - [t_s + \theta_t(t_s)k_a v]h} \delta$$

Simplify above formula again can be

$$\dot{\delta} = j\delta \quad (12)$$

For $t_s \geq 0, \theta_t(t_s) \geq 0, k_a > 0, v \geq 0, h < 0$, thus $j = \frac{h}{1 - [t_s + \theta_t(t_s)k_a v]h} < 0$.

Analyzing formula (12) can reach the conclusion. When δ is greater than zero, $\dot{\delta}$ will be less than zero. It mean that spacing error will be smaller and smaller. And vice versa. As a result, spacing error will converge.

In conclusion, the spacing error of improved spacing policy is convergent. So that this spacing policy is stable.

3. Computer simulation and analysis

Computer simulation should be done under actual traffic scenario. It's necessary to build a full vehicle model, which not only meet the simulation accuracy, but also require some real-time. Therefore, the full vehicle model includes engine model, hydraulic torque converter model, automatic transmission model, tire model, and longitudinal dynamics model. The simulation block diagram of full vehicle is illustrated as Fig. 1. This paper chooses PID control algorithm which is simple and proven and the CACC system's control module is illustrated as Fig.2.

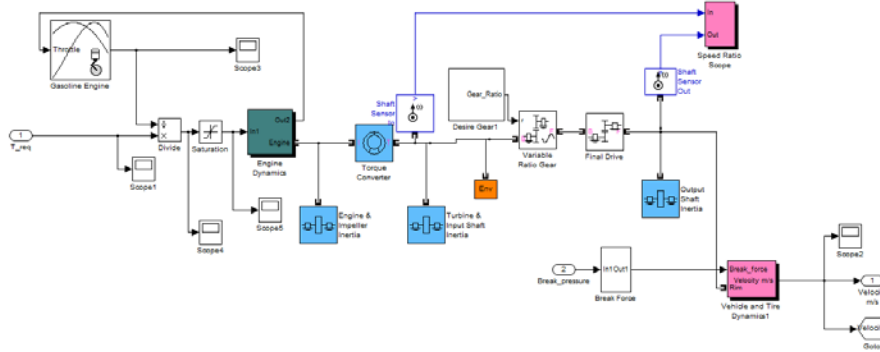

Fig. 1 Simulation block diagram of full vehicle assembly

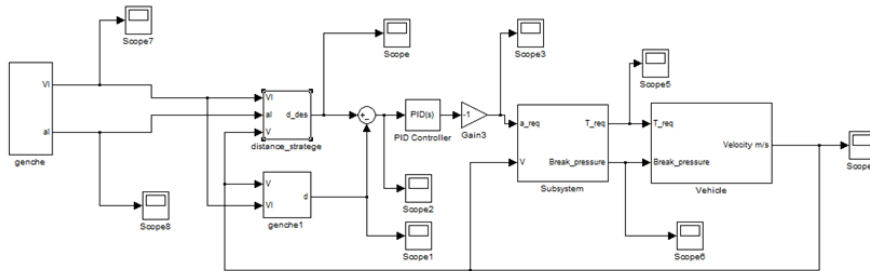

Fig.2 Simulation block diagram of CACC system's control module

This paper uses MATLAB/Simulink to do the computer simulation under four common traffic scenarios: steady following scenario, cut in scenario, approaching scenario and hard brake scenario. According to formula (3), some parameters need to be valued as : $t_0=1.5s, k_a=0.08, k_b=0.1, t_{s_max}=2.2s, t_{s_min} = 0.2s$.

1) Steady following scenario

The simulation of steady following scenario is that two continuous vehicle are running in a straight line. Test vehicle follows the vehicle ahead, and the vehicle in front decelerates firstly and then accelerates. The initial condition sets as: the front vehicle's speed is 18m/s. Self-vehicle's

speed is 15m/s. The distance between the two vehicles is 45 m when t is 0s. Then the front vehicle begins to slow down, and speed reduced to 10m/s when t is 6s. After that the front vehicle begins to accelerate, and its speed accelerates to 18 m/s again when t is 12s. In the end, the ahead vehicle moves at a constant speed. After the simulations of the CTH policy, Yanakiev's policy and policy proposed in this paper, obtaining the desirable distance, the actual distance, velocity and acceleration response curve as shown in Fig. 3.

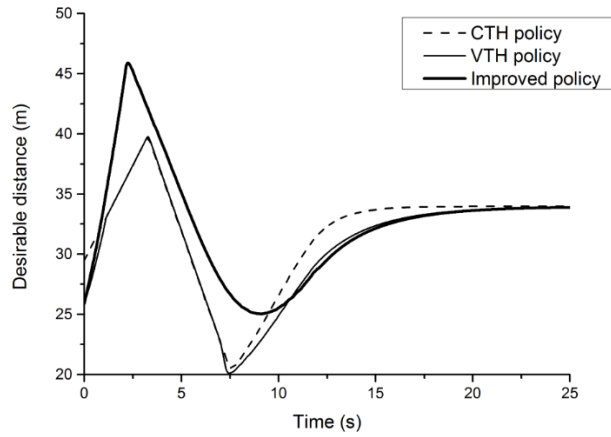

(a) Response curve of desirable distance

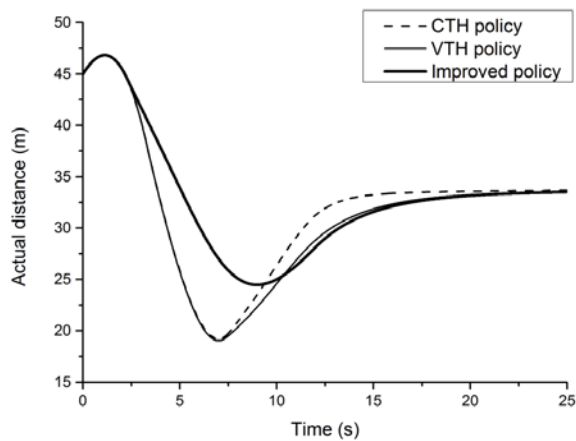

(b) Response curve of actual distance

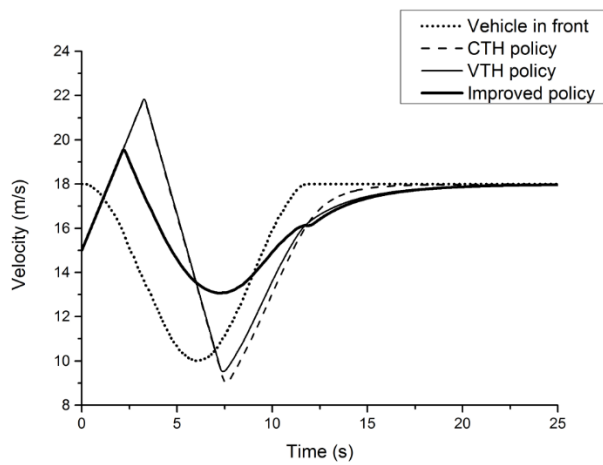

(c) Response curve of speed

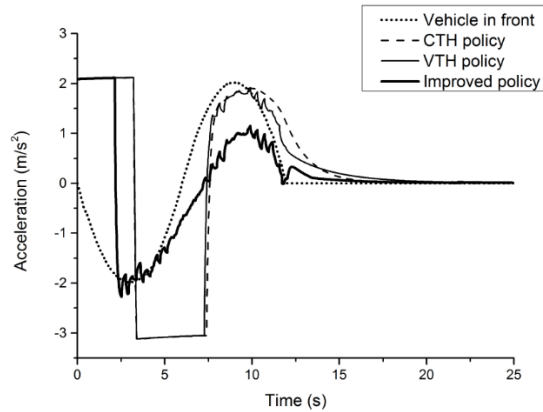

(d)Response curve of acceleration

Fig.3 Simulation of three spacing policies under steady following circumstance

At the beginning of simulation, velocity of front vehicle is greater than the one behind. Vehicles under three spacing policies speed up, acceleration values are all 2.1m/s^2 . With the front vehicle slowing down, improved spacing policy outputs greater desirable distance than other two policies. Because of greater desirable distance, the vehicle with improved policy begins to slow down when t is 2.37s , while other two policies begin at 3.25s . In the meantime, the actual distance which controlled by improved policy is greater than two others to be safer.

Then the front vehicle begins to accelerate at 6s . As the same, vehicle with improved policy begins to accelerate at 6.9s , while CTH begins at 7.5s and VTH at 7.4s . In the view of car following distance, improved policy's is less than two other policies'.

Throughout the entire simulation process, because of faster action, velocity and acceleration of the vehicle with improved policy change much more smoothly than two other.

In conclusion, the policy which considers the front vehicle's acceleration allows the controlled vehicle to act more quickly. The distance of car following is more suitable. What's more, the change of velocity and acceleration is much smoother.

2) Cut in scenario

Cut in scenario refers to that, in the process of car following, another vehicle beside the self-vehicle changes its lane suddenly and inserts in front of the self-vehicle. The initial conditions of the simulation are described as follows: the distance between the two vehicles is 60m , the self-vehicle speed is 20 m/s , and the front vehicle is running with a constant speed of 15 m/s . At this time the self-vehicle has not reached a stable state yet. In the process of chasing the front vehicles, when t is 5s , the cut in scenario happens. The new distance between the self-vehicle and the cut in vehicle turns into 25m . The new targeted vehicle's speed is 15m/s , and it is accelerating. Its velocity increases to 21m/s until t is 16s . Then it keeps an even speed. According to these conditions to do the simulations of the CTH policy, Yanakiev's policy and policy proposed in this paper, and obtain the desirable distance, the actual distance, velocity and acceleration response curve as shown in Fig. 4.

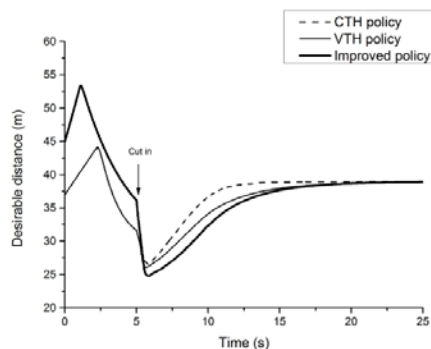

(a) Response curve of desirable distance

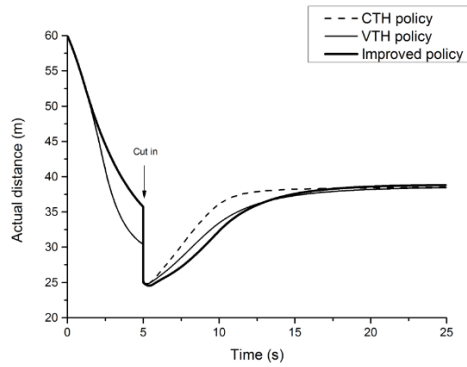

(b) Response curve of actual distance

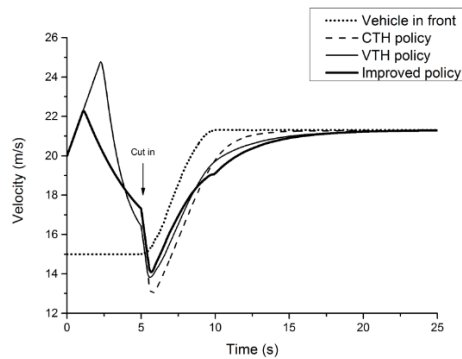

(c) Response curve of speed

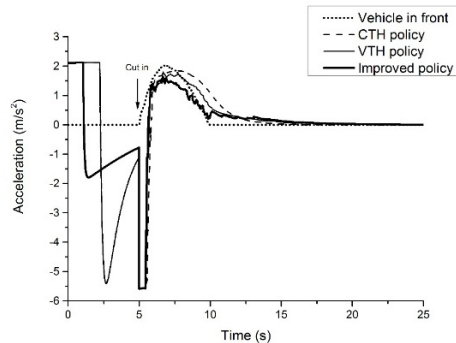

(d) Response curve of acceleration

Fig.4 Simulation of three spacing policies under cut in circumstance

At the beginning, the car following status has not been stable. Vehicles controlled by three policies all accelerate firstly and decelerate later on. But the vehicle with improved policy decelerates earliest, and the t is 1.1s at this moment. Two other policies begin at 2.3s, the deceleration's damping even reach 7 m/s^2 . This damping would let passengers feel very uncomfortable. However, the vehicle controlled by improved policy have smoother deceleration.

When t is 5s, another vehicle beside the self-vehicle changes its lane suddenly and inserts in front of the self-vehicle. At this time, the car following distance drop to 25m. While, the new targeted vehicle is accelerating and its velocity is greater than following vehicle. It's easy to get that the distance between two vehicles will be gradually increased and potential for collision is dispelled. In this situation, vehicle controlled by improved policy reduces declaration and desirable distance earliest to let behind car follows the front in time.

In conclusion, when cut in scenario happens, improved policy avoids collision effectively. This situation is more urgent than steady following, improved policy can still act more quickly and let velocity and acceleration change more smoothly.

3) Vehicle approaching scenario

Approaching scenario can be described as the vehicle travels in a new straight road, then detects

a vehicle running in front. The distance is far more than the safety car following distance. At the beginning of simulation, these two vehicles' speed is consistent. Later on the front vehicle runs with a variable acceleration. Then, the acceleration changes to be constant. After a while, it runs accelerates non-uniformly again. At last its motion state reaches stable. Design the initial conditions of the simulation as follows: the distance between the two vehicles is 100m. The initial two vehicles' speed is 15m/s. After running status of vehicle in front going through a series of changes, its velocity tends to be constant at 15s. According to these conditions to do the simulations of the CTH policy, Yanakiev's policy and policy proposed in this paper, and obtain the desirable distance, the actual distance, velocity and acceleration response curve as shown in Fig. 5.

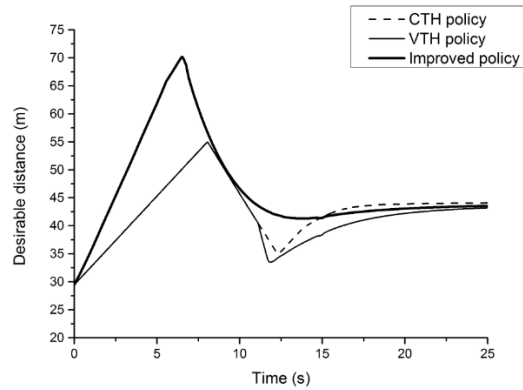

(a) Response curve of desirable distance

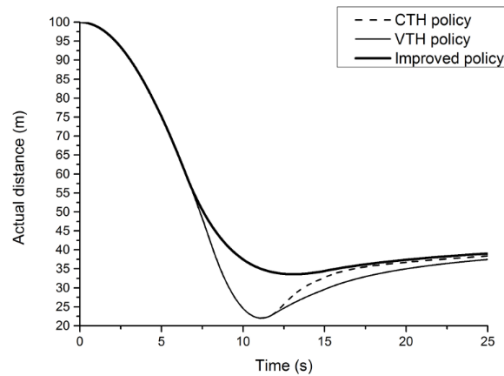

(b) Response curve of actual distance

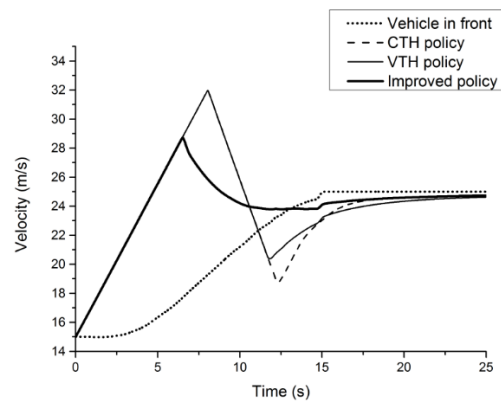

(c) Response curve of speed

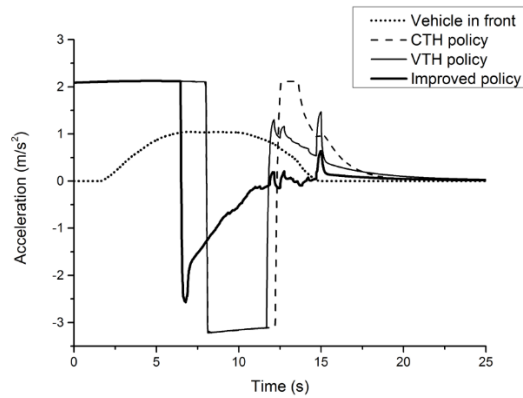

(d) Response curve of acceleration

Fig.5 Simulation of three spacing policies under approaching circumstance

When the distance is far more than safe distance, the vehicles controlled by three policies respectively all accelerate to chase the targeted vehicle. As the distance is decreasing, it's essential to reduce the velocity to keep safe. Later on, the target vehicle changes its motion status continually, especially the acceleration changes non-uniformly. Because the improved policy has already taken the acceleration of front vehicle into account, vehicle with improved policy can act more quickly. What's more, according to response curve of acceleration and velocity, the changes are smoother, so that the riding comfort is much better.

4) Hard braking scenario

Hard brake means that when the car following distance is close, the front vehicle suddenly hits the brakes. Simulation of this scenario is the best to verify the safety of distance policy. Initial conditions are set as: the initial distance is 40m. Their speed is 15m/s. But the following state has not reached stable yet. When t is 5s, the front vehicle brakes hard and stops at 10s. According to these conditions to do the simulations of the CTH policy, Yanakiev's policy and policy proposed in this paper, and obtain the desirable distance, the actual distance, velocity and acceleration response curve as shown in Fig. 6.

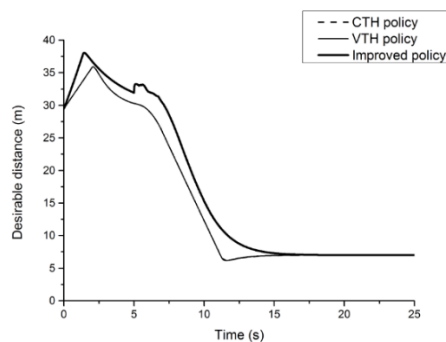

(a) Response curve of desirable distance

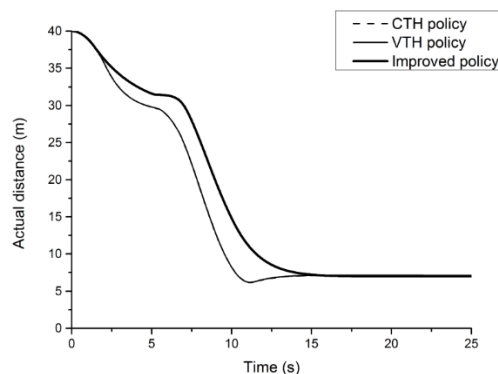

(b) Response curve of actual distance

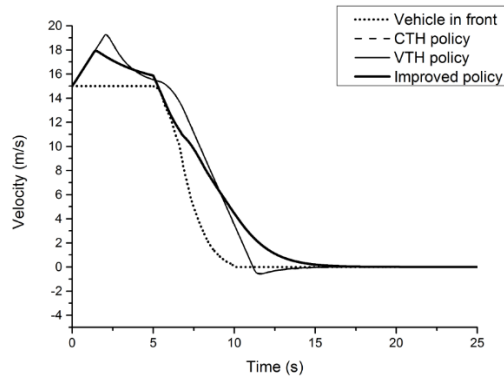

(c) Response curve of speed

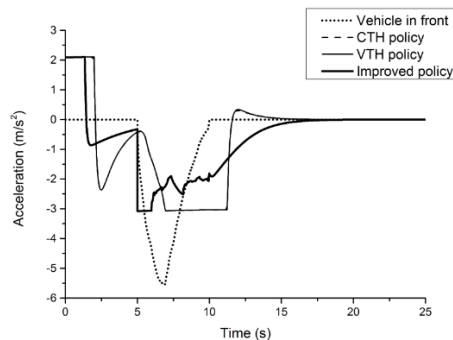

(d) Response curve of acceleration

Fig.6 Simulation of three spacing policies under hard brake circumstance

In this scenario, after hard brake, improved policy controls the vehicle to decelerate immediately and increase desirable distance properly to keep safe. The simulation shows that, apparently, it is effectively to avoid a collision. When the car stops finally, the actual distance is 7m, which is the minimum distance during the simulation as well. If using CACC with spacing policy which is considered acceleration of front vehicle, it will be much safer. The actual distance is reducing gradually until it stops, which the distance is greater than others.

However, when t is 11.1s, velocity controlled by two other policies has become negative. Only when the velocity is negative, can the actual distance be safe. It is worthy of note that, with these two policies, the minimum actual distance is 6m. In other words, if the body is 5 meters long, like a luxury car, the headstock is only 1 meter away from tailstock of the front car. And the car is still slowing down. In this time, driver in the car behind would be very nervous. He couldn't judge whether it is the minimum distance, and whether a collision will be happened. It's a worse experience for customers to use CACC.

In conclusion, utilizing improved spacing policy can increase its safety.

4. Conclusion

This paper mainly focus on cooperative adaptive cruise control (CACC) system and presents a spacing policy which considers relative velocity and acceleration of the vehicle in front. After verify this policy's convergent stability, this paper simulate CTH policy, Yanakiev's policy and improved policy under steady following, cut in, approaching and hard brake scenarios. The simulation shows that the policy presented in this paper get perspectiveness and anti-interference performance of distance control. In all scenario, it controls the vehicle to act more quickly and let the car-following distance more suitable. In steady following and approaching scenario, it significantly improved vehicle ride comfort. In cut in and hard brake scenario, it greatly increase security. The simulation verifies the improvement is effective for controlling vehicles.

References

- [1] Rui ZHANG, Xinping, YAN, Chaozhong, WU. Vehicle adaptive cruise control car road under collaborative environment. Sixth China Intelligent Transport Annual Conference and Seventh International Energy Saving and New Energy Automotive Innovation Development Forum Proceedings (Part 1), U491, P171-180
- [2] Xiaohui QIN, Boyuan, XIE. Cooperative adaptive cruise technological development status and trend. Modern Science & Technology of Telecommunications, 2014:1-7
- [3] Jiaqi MA, Fang Zhou, Demetsky M.J. Evaluating Mobility and Sustainability Benefits of Cooperative Adaptive Cruise Control Using Agent-based Modeling Approach. Systems and Information Design Symposium (SIEDS), 2012:74-78
- [4] Darbha S., Hedrick J. Constant spacing strategies for platooning in automated highway systems. Journal of dynamics system, Measurement and control, 1999, 121:462-470
- [5] Santhanakrishnan K., Rajamani R. On spacing policies for highway vehicle automation. IEEE transactions on transportation systems, 2003, 4(4):198-204
- [6] Ioannou P., Chien C. C. Autonomous intelligent cruise control. IEEE Transactions on Vehicular Technology, 1993, 42:657-672
- [7] Yi-Hsien C., Jyh-Ching J. Longitudinal vehicle control with the spacing policy in consideration of brake input limits. IEEE International Conference on Systems, Man and Cybernetic, 2007:1705-1710
- [8] Tsang-Wei L., Sheue-Ling H., Paul A.G, Effects of time-gap settings of adaptive cruise control on driving performance and subjective acceptance in a bus driving simulator. Safety Sciences, 2009, 37: 620-625
- [9] Swaroop D., Rajagopal K.R. Intelligent cruise control system and traffic flow stability. Transportation Research Part C: Emerging Technologies, 1999, 7(6): 329-352.
- [10] Li P., Shrivastava A. Traffic flow stability induced by constant time headway policy for adaptive cruise control vehicles. Transportation Research Part C: Emerging Technologies, 2002, 10(4):275-301
- [11] Jin Z, Masahiro O., Abdelkader E.K., A safety spacing policy and its impact on highway traffic flow. IEEE Symposium on Intelligent vehicles, 2009:960—965
- [12] Jianlong Z., Ioannou P. Adaptive vehicle following control system with variable time headways. 44th IEEE Conference on Decision and Control, 2005:3880-3885
- [13] Yanakiev D., Kanellakopoulos I. Nonlinear Spacing Policies for Automated Heavy-Duty Vehicles. IEEE Transactions On Vehicular Technology 1998, 47(4):1365-1377